

Wellness objects

Wedi benches

2021

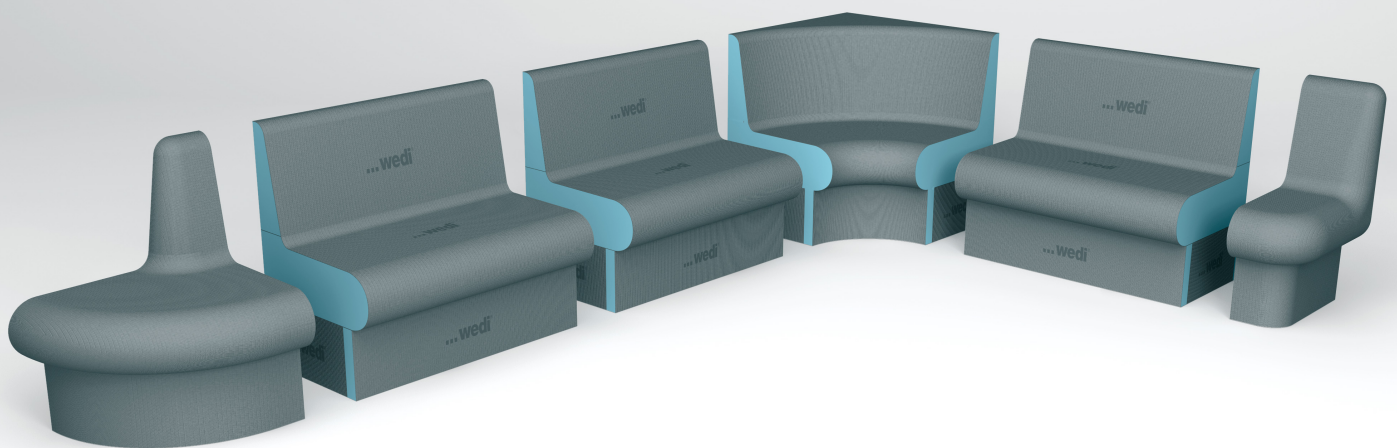



1

When using multi-part bench elements, these should be assembled before placement of the individual benches.



2

When using benches without corner elements, these should be mitred.



3

Connect the bench elements by using wedi 610 adhesive sealant...



4

... to create the desired bench shape and size.

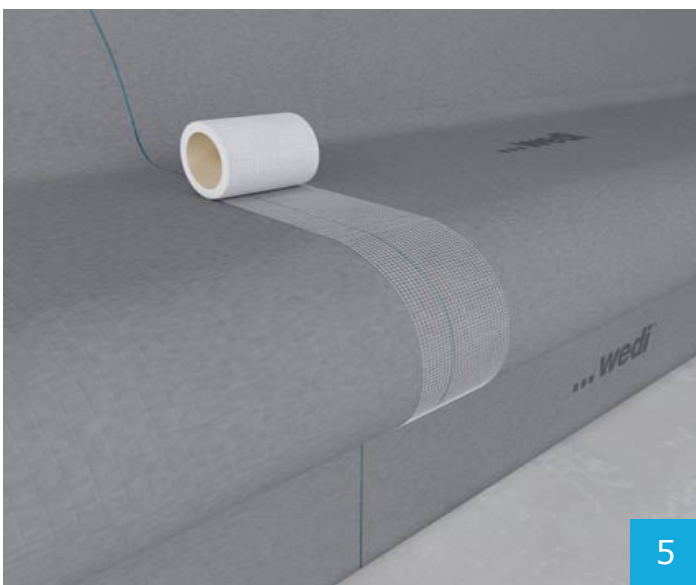

5



Apply wedi Tools reinforcement tape to all joints of the bench elements.



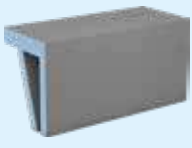

6

Then, the bench elements can be individually tiled.



wedi Sanoasa® bench 1 ▪ finish straight, slope to front

	length × seat depth × height		order no.												
		900 × 380 × 454 mm	W076447020												
		1.200 × 380 × 454 mm	W076447021												
	<ul style="list-style-type: none"> ▪ The separating height for the installation of the Fundo Discreto is 154 mm on the straight side of the substructure element. ▪ technical drawing: see page 123 														
<p>Tileable surfaces</p> <table border="1"> <thead> <tr> <th></th> <th>076447020</th> <th>076447021</th> </tr> </thead> <tbody> <tr> <td>Top</td> <td>0,34 m²</td> <td>0,46 m²</td> </tr> <tr> <td>Front</td> <td>0,41 m²</td> <td>0,54 m²</td> </tr> <tr> <td>Side surface</td> <td>0,17 m²</td> <td>0,17 m²</td> </tr> </tbody> </table>					076447020	076447021	Top	0,34 m ²	0,46 m ²	Front	0,41 m ²	0,54 m ²	Side surface	0,17 m ²	0,17 m ²
	076447020	076447021													
Top	0,34 m ²	0,46 m ²													
Front	0,41 m ²	0,54 m ²													
Side surface	0,17 m ²	0,17 m ²													
<ul style="list-style-type: none"> ▪ accessories <ul style="list-style-type: none"> ▪ required: wedi 610 adhesive sealant, wedi Tools joint reinforcement tape ▪ optional: Fundo Discreto 															
<ul style="list-style-type: none"> ▪ scope of delivery <ul style="list-style-type: none"> ▪ 1 × bench element ▪ 1 × substructure element ▪ 2 × wedi building boards, 6 mm 															

wedi Sanoasa® bench 2 ▪ finish angled, slope to front



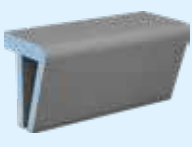

	length × seat depth × height		order no.												
		900 × 380 × 454 mm	W076447022												
		1.200 × 380 × 454 mm	W076447023												
	<ul style="list-style-type: none"> ▪ technical drawing: see page 123 														
<p>Tileable surfaces</p> <table border="1"> <thead> <tr> <th></th> <th>076447022</th> <th>076447023</th> </tr> </thead> <tbody> <tr> <td>Top</td> <td>0,34 m²</td> <td>0,46 m²</td> </tr> <tr> <td>Front</td> <td>0,43 m²</td> <td>0,57 m²</td> </tr> <tr> <td>Side surface</td> <td>0,17 m²</td> <td>0,17 m²</td> </tr> </tbody> </table>					076447022	076447023	Top	0,34 m ²	0,46 m ²	Front	0,43 m ²	0,57 m ²	Side surface	0,17 m ²	0,17 m ²
	076447022	076447023													
Top	0,34 m ²	0,46 m ²													
Front	0,43 m ²	0,57 m ²													
Side surface	0,17 m ²	0,17 m ²													
<ul style="list-style-type: none"> ▪ accessories <ul style="list-style-type: none"> ▪ required: wedi 610 adhesive sealant, wedi Tools joint reinforcement tape 															
<ul style="list-style-type: none"> ▪ scope of delivery <ul style="list-style-type: none"> ▪ 1 × bench element ▪ 1 × substructure element ▪ 2 × wedi building boards, 6 mm 															





wedi Sanoasa® bench 3 ▪ finish rounded, slope to front

	length × seat depth × height		order no.												
		900 × 380 × 454 mm	W076447024												
		1.200 × 380 × 454 mm	W076447025												
	<ul style="list-style-type: none"> ▪ Information about tiling: see page 146 ▪ technical drawing: see page 124 														
<p>Tileable surfaces</p> <table border="1"> <thead> <tr> <th></th> <th>076447024</th> <th>076447025</th> </tr> </thead> <tbody> <tr> <td>Top</td> <td>0,38 m²</td> <td>0,51 m²</td> </tr> <tr> <td>Front</td> <td>0,36 m²</td> <td>0,49 m²</td> </tr> <tr> <td>Side surface</td> <td>0,17 m²</td> <td>0,17 m²</td> </tr> </tbody> </table>					076447024	076447025	Top	0,38 m ²	0,51 m ²	Front	0,36 m ²	0,49 m ²	Side surface	0,17 m ²	0,17 m ²
	076447024	076447025													
Top	0,38 m ²	0,51 m ²													
Front	0,36 m ²	0,49 m ²													
Side surface	0,17 m ²	0,17 m ²													
<ul style="list-style-type: none"> ▪ accessories <ul style="list-style-type: none"> ▪ required: wedi 610 adhesive sealant, wedi Tools joint reinforcement tape ▪ optional: Fundo Discreto 															
<ul style="list-style-type: none"> ▪ scope of delivery <ul style="list-style-type: none"> ▪ 1 × bench element ▪ 1 × substructure element ▪ 2 × wedi building boards, 6 mm 															

wedi Sanoasa® Top ready-to-use surface ▪ finish rounded





for wedi Sanoasa bench 3

	length × seat depth × height		order no.
		1.200 × 380 × 460 mm	
	1.200 × 380 × 460 mm		W076447532
	1.200 × 380 × 460 mm *		W076447542
	1.200 × 380 × 460 mm *		W076447522
	1.200 × 380 × 460 mm *		W076447502







-  Each wedi Sanoasa Top is the perfect complement to the wedi Sanoasa bench 3 with rounded finish.
 - High-quality seamless surface
 -  Adhesion to the bench is done with wedi 610 adhesive sealant.
 - technical drawing: see page 124
 -  accessories
 - required: wedi 610 adhesive sealant
 -  outer packaging/pallet edging
 - pallet edging 10 units
- * delivery time approx. 3 weeks ex-works.

wedi Sanoasa® bench 4 ▪ straight, slope to front

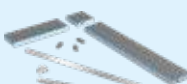
	length × seat depth × thickness		order no.
		1.200 × 380 × 80 mm	



-  The wedi Sanoasa bench 4 gets by without a substructure if it is attached on 3 sides and is therefore free-standing.
 -  technical drawing: see page 124
 -  scope of delivery
 - 1 × seat element
 - 2 × installation beams
- Tileable surfaces
- | | |
|--------|---------------------|
| | 076447041 |
| Top | 0,46 m ² |
| Front | 0,1 m ² |
| Bottom | 0,46 m ² |
-  accessories
 - required: wedi 610 adhesive sealant, wedi Tools joint reinforcement tape

wedi Sanoasa® floating bench ▪ individual

	dimensions		order no.
		1.500 – 3.000 × 450 mm	
			W076400762
			W076400761
			W076400763
			W76400764
			W076400765

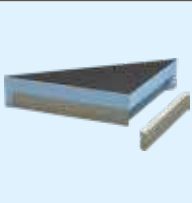

-  Customer-specific custom product
 - Maximum floating length of 3.000 mm
 - Approved load: max. 170 kg/m

wedi Sanoasa® corner seat element

	length × seat depth × thickness		order no.
	size M	600 × 300 × 100 mm	W073784302
	size L	800 × 400 × 100 mm	W073784402
	<ul style="list-style-type: none"> technical drawing: see page 124 		<ul style="list-style-type: none"> scope of delivery <ul style="list-style-type: none"> 1 × seat element 2 × installation beams 1 × wedi Tools joint reinforcement tape, 3 m
	Tileable surfaces		
		073784302	073784402
	Front	0,09 m ²	0,16 m ²
	Rear	0,09 m ²	0,16 m ²
	Side surface	0,06 m ²	0,08 m ²
<ul style="list-style-type: none"> accessories <ul style="list-style-type: none"> required: wedi 610 adhesive sealant 			

wedi Sanoasa® Comoda bench element ▪ slope to front

for Sanoasa Comoda base element

	length × width × height		order no.
		1.000 × 600 × 620 mm	W076447015
		2.000 × 600 × 620 mm	W076438000
	<ul style="list-style-type: none"> Information about tiling: see page 146 technical drawing: see page 125 		<ul style="list-style-type: none"> scope of delivery <ul style="list-style-type: none"> 1 × back rest 1 × seat
	Tileable surfaces		
		076447015	076438000
	Front	1,15 m ²	2,3 m ²
	Rear	0,62 m ²	1,24 m ²
	Side surface	0,31 m ²	0,31 m ²
<ul style="list-style-type: none"> accessories <ul style="list-style-type: none"> required: wedi 610 adhesive sealant, wedi Tools joint reinforcement tape optional: with integrated electric heating set, with integrated hot water heating set 			

wedi Sanoasa® Comoda Base element

for Sanoasa Comoda bench element

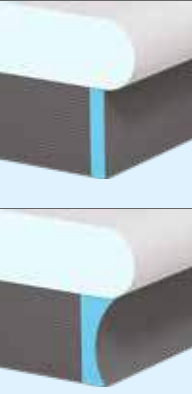
	length × width × height		order no.
	finish straight	1.000 × 500 × 250 mm	W076437000
	finish round	1.000 × 500 × 250 mm	W076437500
	<ul style="list-style-type: none"> technical drawing: see page 125 		
	Tileable surfaces		
		076437000	076437500
	Front	0,3 m ²	0,3 m ²
	Rear	0,25 m ²	0,25 m ²
	Side surface	0,13 m ²	0,13 m ²
<ul style="list-style-type: none"> accessories <ul style="list-style-type: none"> required: wedi 610 adhesive sealant, wedi Tools joint reinforcement tape 			

wedi Sanoasa® Comoda corner bench element ▪ 90°, slope to front
for Sanoasa Comoda corner base element 90°

	length × width × height		order no.
transition straight	650 × 650 × 620 mm		W076447004
transition rounded	850 × 850 × 620 mm		W076447000

- Information about tiling: see page 146
- technical drawing: see page 125

delivery time approx. 2 weeks ex-works.

Tileable surfaces

	076447004	076447000
Front	0,9 m ²	1,2 m ²
Rear	0,9 m ²	1,1 m ²
Side surface	0,31 m ²	0,31 m ²

accessories

- required: wedi 610 adhesive sealant, wedi Tools joint reinforcement tape
- optional: with integrated electric heating set, with integrated hot water heating set
- not compatible: Sanoasa Comoda support element with rounded end

wedi Sanoasa® Comoda corner base element ▪ 90°, finish straight
for Sanoasa Comoda corner bench element 90°

	length × width × height		order no.
transition straight	650 × 650 × 250 mm		W076447005
transition rounded	850 × 850 × 250 mm		W076447001

- technical drawing: see page 125

delivery time approx. 2 weeks ex-works.

Tileable surfaces



	076447005	076447001
Front	0,1 m ²	0,2 m ²
Rear	0,4 m ²	0,5 m ²
Side surface	0,25 m ²	0,25 m ²

accessories

- required: wedi 610 adhesive sealant, wedi Tools joint reinforcement tape



wedi Sanoasa® Comoda end bench element ▀ left, slope to front

for Sanoasa Comoda end base element

		length × width × height	order no.												
	Corner radius 200 mm	600 × 300 × 620 mm	W076447011												
	Corner radius 600 mm	700 × 600 × 620 mm	W076447008												
<ul style="list-style-type: none"> Information about tiling: see page 146 technical drawing: see page 126 		 delivery time approx. 2 weeks ex-works.													
Tileable surfaces <table border="1" style="width: 100%; border-collapse: collapse;"> <thead> <tr> <th></th> <th>076447011</th> <th>076447008</th> </tr> </thead> <tbody> <tr> <td>Front</td> <td>0,6 m²</td> <td>0,8 m²</td> </tr> <tr> <td>Rear</td> <td>0,2 m²</td> <td>0,3 m²</td> </tr> <tr> <td>Side surface</td> <td>0,31 m²</td> <td>0,31 m²</td> </tr> </tbody> </table>					076447011	076447008	Front	0,6 m ²	0,8 m ²	Rear	0,2 m ²	0,3 m ²	Side surface	0,31 m ²	0,31 m ²
	076447011	076447008													
Front	0,6 m ²	0,8 m ²													
Rear	0,2 m ²	0,3 m ²													
Side surface	0,31 m ²	0,31 m ²													
 accessories <ul style="list-style-type: none"> required: wedi 610 adhesive sealant, wedi Tools joint reinforcement tape optional: with integrated electric heating set, with integrated hot water heating set 															



wedi Sanoasa® Comoda end bench element ▀ right, slope to front

for Sanoasa Comoda end base element

		length × width × height	order no.												
	Corner radius 200 mm	600 × 300 × 620 mm	W076447012												
	Corner radius 600 mm	700 × 600 × 620 mm	W076447009												
<ul style="list-style-type: none"> Information about tiling: see page 146 technical drawing: see page 126 		 delivery time approx. 2 weeks ex-works.													
Tileable surfaces <table border="1" style="width: 100%; border-collapse: collapse;"> <thead> <tr> <th></th> <th>076447012</th> <th>076447009</th> </tr> </thead> <tbody> <tr> <td>Front</td> <td>0,6 m²</td> <td>0,8 m²</td> </tr> <tr> <td>Rear</td> <td>0,2 m²</td> <td>0,3 m²</td> </tr> <tr> <td>Side surface</td> <td>0,31 m²</td> <td>0,31 m²</td> </tr> </tbody> </table>					076447012	076447009	Front	0,6 m ²	0,8 m ²	Rear	0,2 m ²	0,3 m ²	Side surface	0,31 m ²	0,31 m ²
	076447012	076447009													
Front	0,6 m ²	0,8 m ²													
Rear	0,2 m ²	0,3 m ²													
Side surface	0,31 m ²	0,31 m ²													
 accessories <ul style="list-style-type: none"> required: wedi 610 adhesive sealant, wedi Tools joint reinforcement tape optional: with integrated electric heating set, with integrated hot water heating set 															

wedi Sanoasa® Comoda end base element

for Sanoasa Comoda end bench element

		length × width × height	order no.												
	Corner radius 200 mm	500 × 200 × 250 mm	W076447013												
	Corner radius 600 mm	600 × 500 × 250 mm	W076447010												
<ul style="list-style-type: none"> The element can be installed both to the left and to the right. Information about tiling: see page 146 technical drawing: see page 127 		 delivery time approx. 2 weeks ex-works.													
Tileable surfaces <table border="1" style="width: 100%; border-collapse: collapse;"> <thead> <tr> <th></th> <th>076447013</th> <th>076447010</th> </tr> </thead> <tbody> <tr> <td>Front</td> <td>0,2 m²</td> <td>0,3 m²</td> </tr> <tr> <td>Rear</td> <td>0,1 m²</td> <td>0,2 m²</td> </tr> <tr> <td>Side surface</td> <td>0,25 m²</td> <td>0,25 m²</td> </tr> </tbody> </table>					076447013	076447010	Front	0,2 m ²	0,3 m ²	Rear	0,1 m ²	0,2 m ²	Side surface	0,25 m ²	0,25 m ²
	076447013	076447010													
Front	0,2 m ²	0,3 m ²													
Rear	0,1 m ²	0,2 m ²													
Side surface	0,25 m ²	0,25 m ²													
 accessories <ul style="list-style-type: none"> required: wedi 610 adhesive sealant, wedi Tools joint reinforcement tape 															

wedi Sanoasa® Comoda armrest

for Sanoasa Comoda bench element

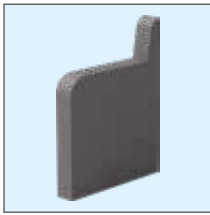

	length × width × height	order no.
	650 × 105 × 870 mm	W076447014

- 🔧
 - The element can be installed both to the left and to the right.
 - Information about tiling: see page 146
 - technical drawing: see page 127
- 📦
 - delivery time approx. 2 weeks ex-works.

Tileable surfaces

	076447014
Front	0,75 m ²
Rear	0,1 m ²
Side surface	0,9 m ²

- 🔧
 - accessories
 - required: wedi 610 adhesive sealant, wedi Tools joint reinforcement tape

wedi Sanoasa® Bellina bench element ▪ slope to front

for Sanoasa Bellina base element



	length × width × height	order no.
	1.000 × 486 × 240 mm	W076448015
	2.000 × 486 × 240 mm	W076441000

- 🔧
 - Information about tiling: see page 146
 - technical drawing: see page 127
- 📦
 - delivery time approx. 2 weeks ex-works.

Tileable surfaces

	076448015	076441000
Front	0,73 m ²	1,46 m ²
Rear	0,25 m ²	0,5 m ²
Side surface	0,2 m ²	0,2 m ²

- 🔧
 - accessories
 - required: wedi 610 adhesive sealant, wedi Tools joint reinforcement tape
 - optional: with integrated electric heating set, with integrated hot water heating set

wedi Sanoasa® Bellina Base element

for Sanoasa Bellina bench element



	length × width × height	order no.
finish straight	1.000 × 386 × 250 mm	W076441500
finish round	1.000 × 425 × 250 mm	W076441600

- 🔧
 - technical drawing: see page 127
- 📦
 - delivery time approx. 2 weeks ex-works.

Tileable surfaces

	076441500	076441600
Front	0,25 m ²	0,28 m ²
Rear	0,25 m ²	0,25 m ²
Side surface	0,2 m ²	0,2 m ²

- 🔧
 - accessories
 - required: wedi 610 adhesive sealant, wedi Tools joint reinforcement tape

wedi Sanoasa® Bellina corner bench element ▪ 90°, slope to front

for Sanoasa Bellina corner base element 90°

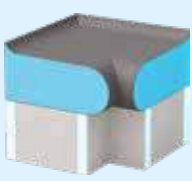
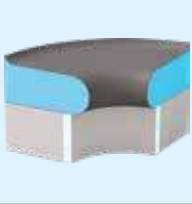
		length × width × height	order no.												
	transition straight	550 × 550 × 240 mm	W076448004												
	transition rounded	736 × 736 × 240 mm	W076448000												
		<ul style="list-style-type: none"> Information about tiling: see page 146 technical drawing: see page 128 													
		<ul style="list-style-type: none"> delivery time approx. 2 weeks ex-works. 													
		<p>Tileable surfaces</p> <table border="1"> <thead> <tr> <th></th> <th>076448004</th> <th>076448000</th> </tr> </thead> <tbody> <tr> <td>Front</td> <td>0,35 m²</td> <td>0,45 m²</td> </tr> <tr> <td>Rear</td> <td>0,3 m²</td> <td>0,3 m²</td> </tr> <tr> <td>Side surface</td> <td>0,19 m²</td> <td>0,19 m²</td> </tr> </tbody> </table>			076448004	076448000	Front	0,35 m ²	0,45 m ²	Rear	0,3 m ²	0,3 m ²	Side surface	0,19 m ²	0,19 m ²
	076448004	076448000													
Front	0,35 m ²	0,45 m ²													
Rear	0,3 m ²	0,3 m ²													
Side surface	0,19 m ²	0,19 m ²													
<ul style="list-style-type: none"> accessories 															
<ul style="list-style-type: none"> required: wedi 610 adhesive sealant, wedi Tools joint reinforcement tape optional: with integrated electric heating set, with integrated hot water heating set not compatible: Sanoasa Bellina support element with rounded end 															

wedi Sanoasa® Bellina corner base element ▪ 90°, finish straight

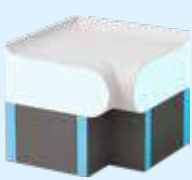
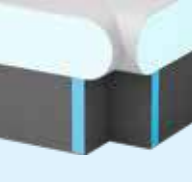

for Sanoasa Bellina corner bench element 90°

		length × width × height	order no.												
	transition straight	550 × 550 × 250 mm	W076448005												
	transition rounded	736 × 736 × 250 mm	W076448001												
		<ul style="list-style-type: none"> technical drawing: see page 128 													
		<ul style="list-style-type: none"> delivery time approx. 2 weeks ex-works. 													
		<p>Tileable surfaces</p> <table border="1"> <thead> <tr> <th></th> <th>076448005</th> <th>076448001</th> </tr> </thead> <tbody> <tr> <td>Front</td> <td>0,1 m²</td> <td>0,15 m²</td> </tr> <tr> <td>Rear</td> <td>0,28 m²</td> <td>0,3 m²</td> </tr> <tr> <td>Side surface</td> <td>0,2 m²</td> <td>0,2 m²</td> </tr> </tbody> </table>			076448005	076448001	Front	0,1 m ²	0,15 m ²	Rear	0,28 m ²	0,3 m ²	Side surface	0,2 m ²	0,2 m ²
	076448005	076448001													
Front	0,1 m ²	0,15 m ²													
Rear	0,28 m ²	0,3 m ²													
Side surface	0,2 m ²	0,2 m ²													
<ul style="list-style-type: none"> accessories 															
<ul style="list-style-type: none"> required: wedi 610 adhesive sealant, wedi Tools joint reinforcement tape 															

wedi Sanoasa® Bellina end bench element ▀ left, slope to front

for Sanoasa Bellina end base element

	length × width × height		order no.
	Corner radius 200 mm	486 × 300 × 240 mm	
Corner radius 486 mm	600 × 486 × 240 mm		W076448008

 Information about tiling: see page 146
 technical drawing: see page 128

 delivery time approx. 2 weeks ex-works.

Tileable surfaces

	076448011	076448008
Front	0,3 m ²	0,4 m ²
Rear	0,2 m ²	0,2 m ²
Side surface	0,19 m ²	0,19 m ²



 accessories

- required: wedi 610 adhesive sealant, wedi Tools joint reinforcement tape
- optional: with integrated electric heating set, with integrated hot water heating set

wedi Sanoasa® Bellina end bench element ▀ right, slope to front

for Sanoasa Bellina end base element

	length × width × height		order no.
	Corner radius 200 mm	486 × 300 × 240 mm	
Corner radius 486 mm	600 × 486 × 240 mm		W076448009

 Information about tiling: see page 146
 technical drawing: see page 128

 delivery time approx. 2 weeks ex-works.

Tileable surfaces

	076448012	076448009
Front	0,3 m ²	0,4 m ²
Rear	0,2 m ²	0,2 m ²
Side surface	0,19 m ²	0,19 m ²



 accessories

- required: wedi 610 adhesive sealant, wedi Tools joint reinforcement tape
- optional: with integrated electric heating set, with integrated hot water heating set

wedi Sanoasa® Bellina end base element

for Sanoasa Bellina end bench element

	length × width × height		order no.
	Corner radius 200 mm	386 × 200 × 250 mm	
Corner radius 486 mm	500 × 486 × 250 mm		W076448010

 The element can be installed both to the left and to the right.
 Information about tiling: see page 146
 technical drawing: see page 129

 delivery time approx. 2 weeks ex-works.

Tileable surfaces





	076448013	076448010
Front	0,15 m ²	0,2 m ²
Rear	0,15 m ²	0,25 m ²
Side surface	0,2 m ²	0,2 m ²

 accessories





- required: wedi 610 adhesive sealant, wedi Tools joint reinforcement tape

wedi Sanoasa® Bellina armrest





for Sanoasa Bellina bench element

	length × width × height		order no.
	550 × 105 × 650 mm		W076448014
	<ul style="list-style-type: none"> The element can be installed both to the left and to the right. Information about tiling: see page 146 technical drawing: see page 129 		 delivery time approx. 2 weeks ex-works.
Tileable surfaces			
		076448014	
Front		0,65 m ²	
Rear		0,1 m ²	
Side surface		0,72 m ²	
	accessories <ul style="list-style-type: none"> required: wedi 610 adhesive sealant, wedi Tools joint reinforcement tape 		

wedi Sanoasa® lounge 1

	length × width × height			order no.
	without heating	1.920 × 700 × 672 mm		W076400042
	with electric heating, installed in the factory	1.920 × 700 × 672 mm		W076400043
	with hot water heating, installed in the factory	1.920 × 700 × 672 mm		W076400044
	<ul style="list-style-type: none"> Information about tiling: see page 146 technical drawing: see page 129 			 delivery time approx. 4 – 5 weeks ex-works.
Tileable surfaces				
	076400042	076400043	076400044	
Lounger element	4,15 m ²	4,15 m ²	4,15 m ²	
Base element	0,47 m ²	0,47 m ²	0,47 m ²	
	accessories <ul style="list-style-type: none"> required: wedi 610 adhesive sealant, wedi Tools joint reinforcement tape 			

wedi Sanoasa® lounge 2

	length × width × height			order no.
	without heating	1.442 × 700 × 1.104 mm		W076400045
	with electric heating, installed in the factory	1.442 × 700 × 1.104 mm		W076400046
	with hot water heating, installed in the factory	1.442 × 700 × 1.104 mm		W076400047
	<ul style="list-style-type: none"> Information about tiling: see page 146 technical drawing: see page 129 			 delivery time approx. 4 – 5 weeks ex-works.
Tileable surfaces				
	076400045	076400046	076400047	
Lounger element	2,33 m ²	2,33 m ²	2,33 m ²	
Base element	1,51 m ²	1,51 m ²	1,51 m ²	
	accessories <ul style="list-style-type: none"> required: wedi 610 adhesive sealant, wedi Tools joint reinforcement tape 			

wedi Sanoasa® lounge 3



	length × width × height	order no.
without heating	1.856 × 700 × 764 mm	W076400049
with electric heating, installed in the factory	1.856 × 700 × 764 mm	W076400050
with hot water heating, installed in the factory	1.856 × 700 × 764 mm	W076400051

- Information about tiling: see page 146
- technical drawing: see page 130

delivery time approx. 4 – 5 weeks ex-works.

Tileable surfaces

	076400049	076400050	076400051
Lounger element	3,07 m ²	3,07 m ²	3,07 m ²
Base element	1,28 m ²	1,28 m ²	1,28 m ²

- accessories
 - required: wedi 610 adhesive sealant, wedi Tools joint reinforcement tape

wedi Sanoasa® lounge 4



	length × width × height	order no.
without heating	2.014 × 700 × 921 mm	W076400053
with electric heating, installed in the factory	2.014 × 700 × 921 mm	W076400054
with hot water heating, installed in the factory	2.014 × 700 × 921 mm	W076400055

- Information about tiling: see page 146
- technical drawing: see page 130

delivery time approx. 4 – 5 weeks ex-works.

Tileable surfaces

	076400053	076400054	076400055
Lounger element	3,18 m ²	3,18 m ²	3,18 m ²
Base element	3,05 m ²	3,05 m ²	3,05 m ²

- accessories
 - required: wedi 610 adhesive sealant, wedi Tools joint reinforcement tape

wedi Sanoasa® lounge 5



	length × width × height	order no.
without heating	1.738 × 700 × 890 mm	W076400059
with electric heating, installed in the factory	1.738 × 700 × 890 mm	W076400060
with hot water heating, installed in the factory	1.738 × 700 × 890 mm	W076400061

- Information about tiling: see page 146
- technical drawing: see page 130

delivery time approx. 4 – 5 weeks ex-works.

Tileable surfaces

	076400059	076400060	076400061
Lounger element	4,16 m ²	4,16 m ²	4,16 m ²

- accessories
 - required: wedi Tools joint reinforcement tape

wedi Sanoasa® bench 1 ■ finish straight, slope to front

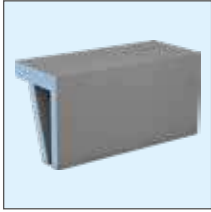

wedi Sanoasa bench 1, 900 mm

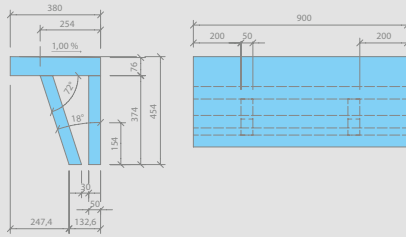

wedi Sanoasa bench 1, 1.200 mm

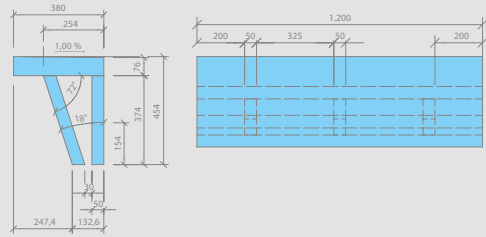

wedi Sanoasa® bench 2 ■ finish angled, slope to front

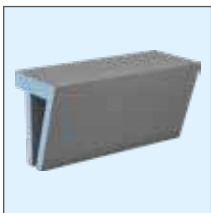

wedi Sanoasa bench 2, 900 mm

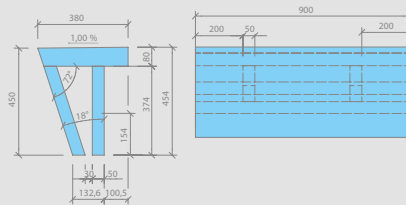

wedi Sanoasa bench 2, 1.200 mm

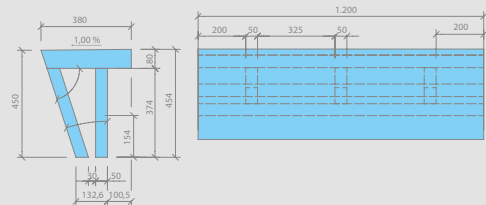

wedi Sanoasa® bench 3 ■ finish rounded, slope to front

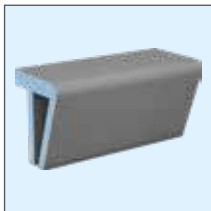

wedi Sanoasa bench 3, 900 mm

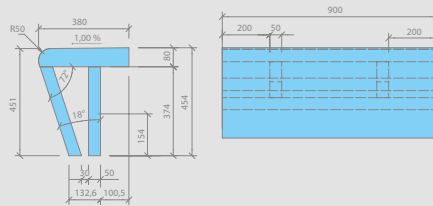

wedi Sanoasa bench 3, 1.200 mm

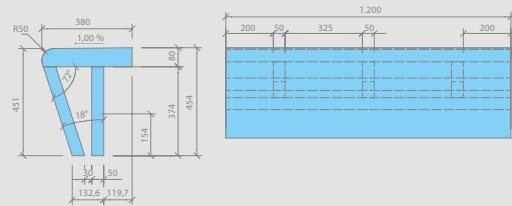

wedi Sanoasa® Top ready-to-use surface ▪ finish rounded
for wedi Sanoasa bench 3

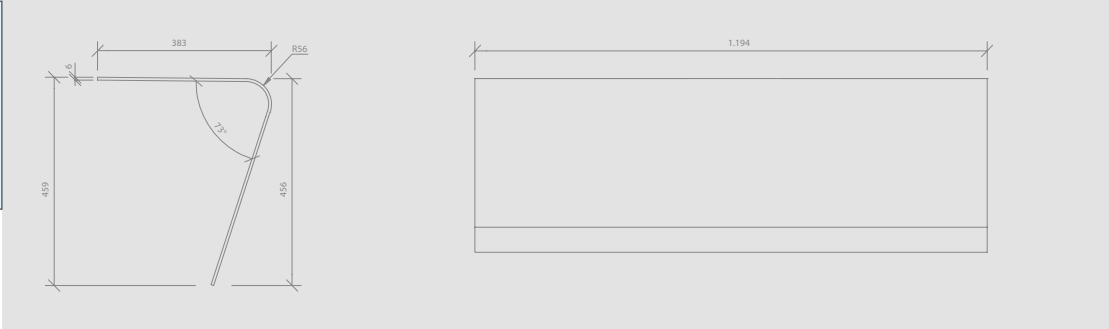

wedi Sanoasa® bench 4 ▪ straight, slope to front

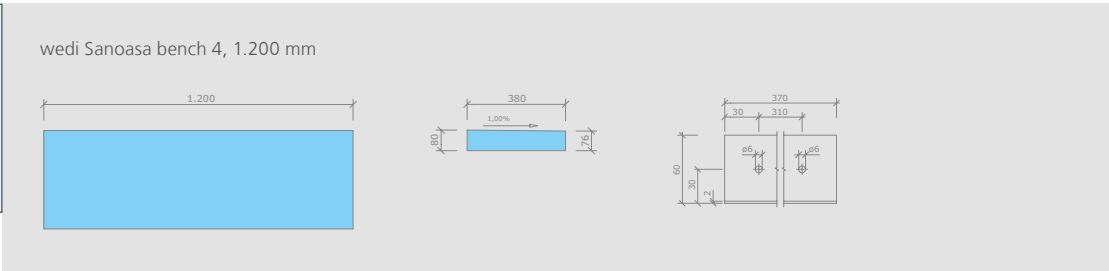
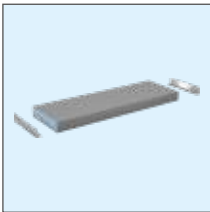

wedi Sanoasa® corner seat element

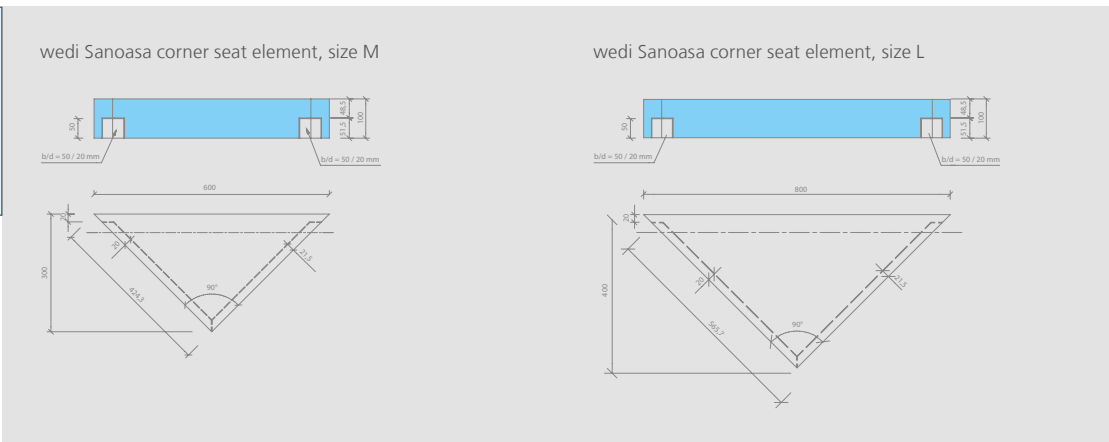
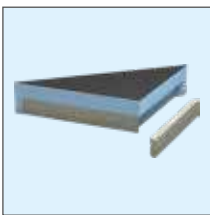

wedi Sanoasa® Comoda bench/base element

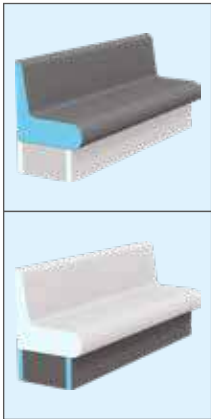

wedi Sanoasa Comoda bench element, finish straight

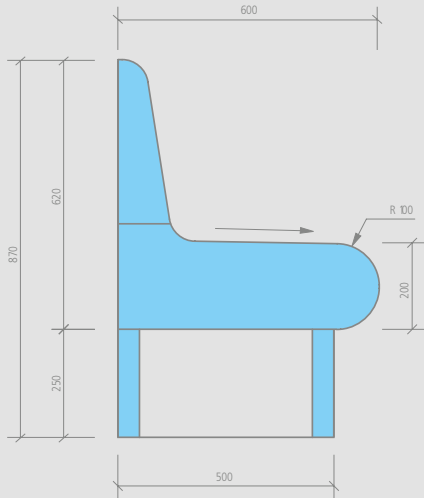

wedi Sanoasa Comoda bench element, finish round

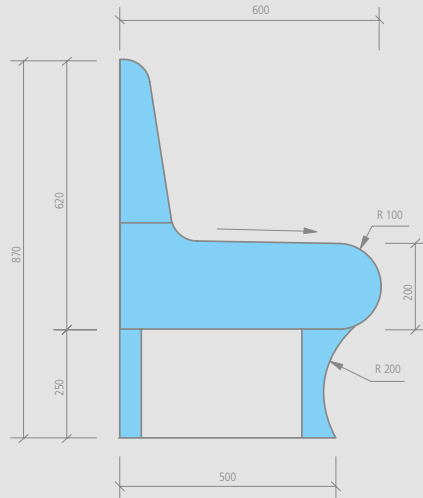

wedi Sanoasa® Comoda corner bench/base element ■ 90°

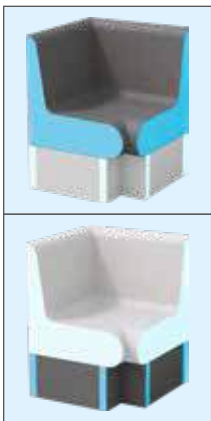

wedi Sanoasa Comoda corner bench element 90°, transition straight

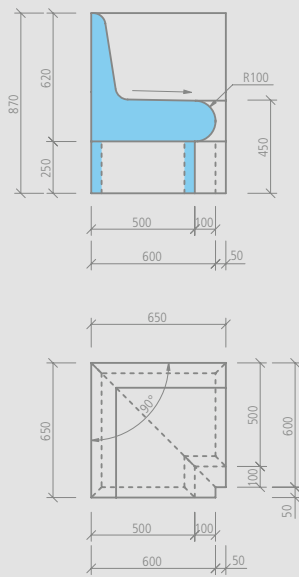

wedi Sanoasa Comoda corner bench element 90°, transition rounded

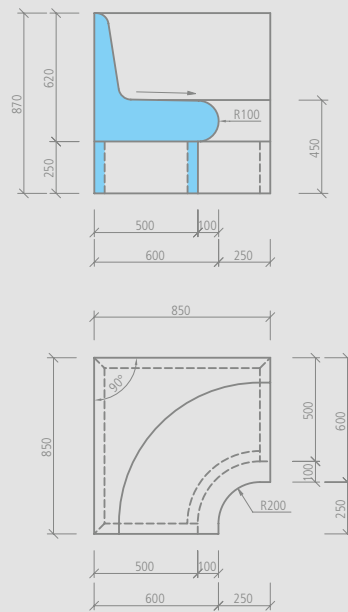

wedi Sanoasa® Comoda end bench element ▀ left, slope to front

for Sanoasa Comoda end base element

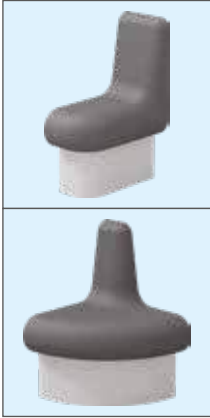

wedi Sanoasa Comoda end bench element left,
Corner radius 200 mm

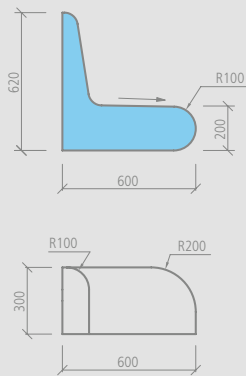

wedi Sanoasa Comoda end bench element left,
Corner radius 600 mm

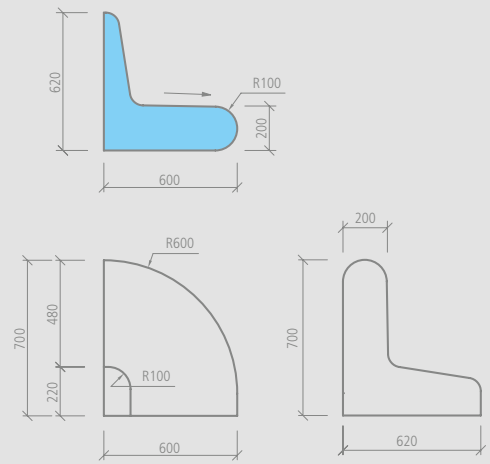

wedi Sanoasa® Comoda end bench element ▀ right, slope to front

for Sanoasa Comoda end base element

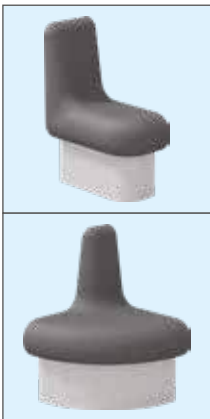

wedi Sanoasa Comoda end bench element right,
Corner radius 200 mm

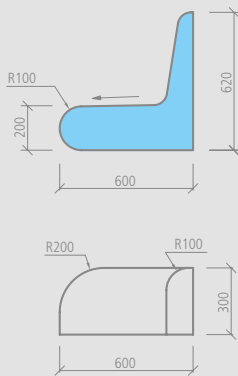

wedi Sanoasa Comoda end bench element right,
Corner radius 600 mm

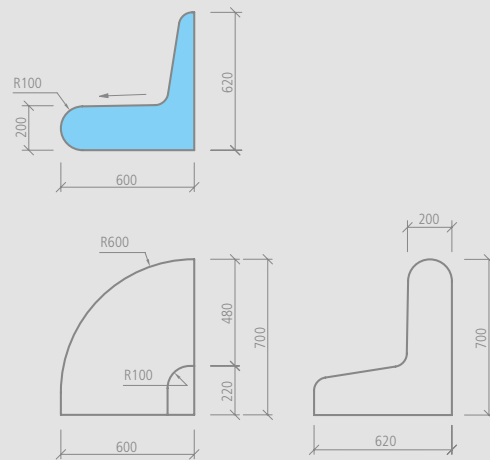

wedi Sanoasa® Comoda end base element

for Sanoasa Comoda end bench element



wedi Sanoasa Comoda end base element,
Corner radius 200 mm

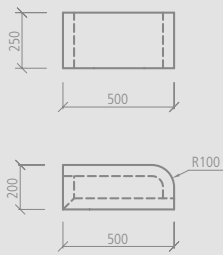

wedi Sanoasa Comoda end base element,
Corner radius 600 mm

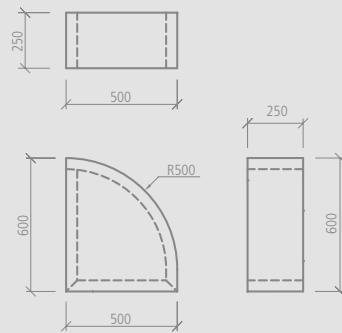

wedi Sanoasa® Comoda armrest

for Sanoasa Comoda bench element

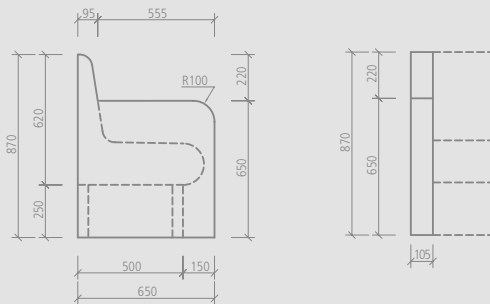

wedi Sanoasa® Bellina bench/base element

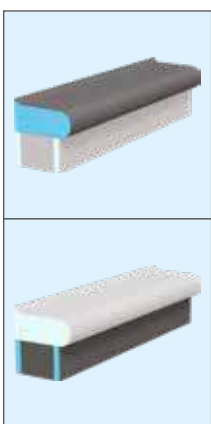

wedi Sanoasa Bellina bench element, finish length straight

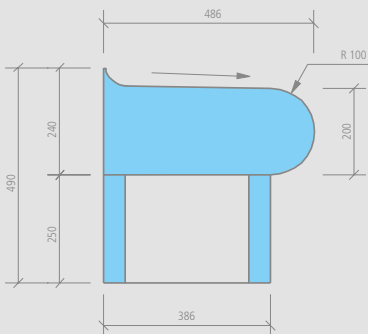

wedi Sanoasa Bellina bench element, finish length round

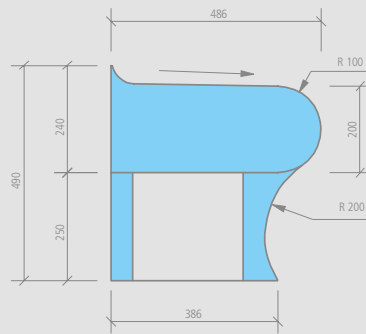

wedi Sanoasa® Bellina corner bench/base element ▪ 90°

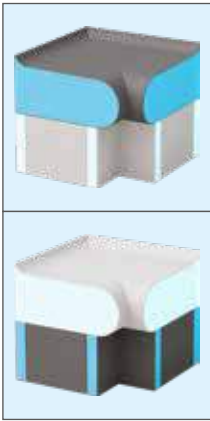

wedi Sanoasa Bellina corner bench element 90°, transition straight

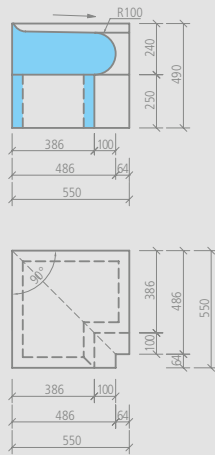

wedi Sanoasa Bellina corner bench element 90°, transition rounded

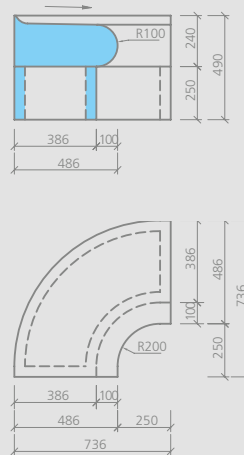

wedi Sanoasa® Bellina end bench element ▪ left, slope to front
for Sanoasa Bellina end base element

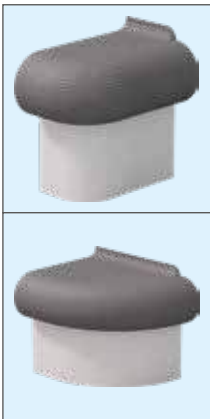

wedi Sanoasa Bellina end bench element left, Corner radius 200 mm

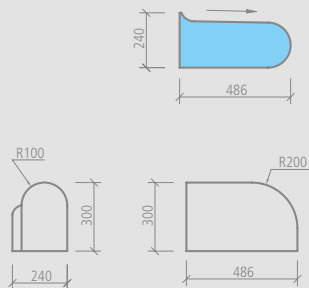

wedi Sanoasa Bellina end bench element left, Corner radius 486 mm

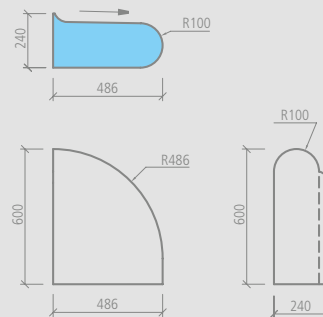

wedi Sanoasa® Bellina end bench element ▪ right, slope to front
for Sanoasa Bellina end base element



wedi Sanoasa Bellina end bench element right, Corner radius 200 mm

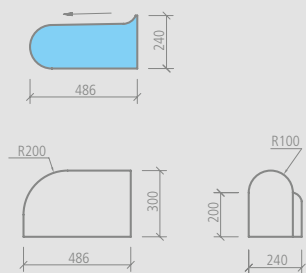

wedi Sanoasa Bellina end bench element right, Corner radius 486 mm

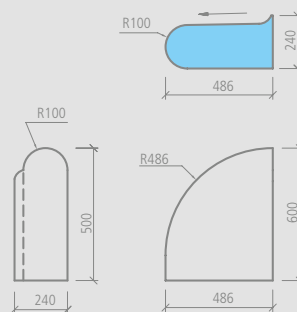

wedi Sanoasa® Bellina end base element

for Sanoasa Bellina end bench element



wedi Sanoasa Bellina end base element,
Corner radius 200 mm

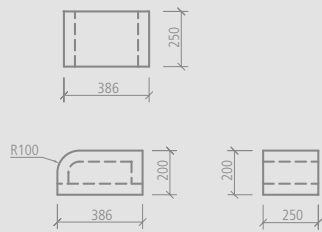

wedi Sanoasa Bellina end base element,
Corner radius 486 mm

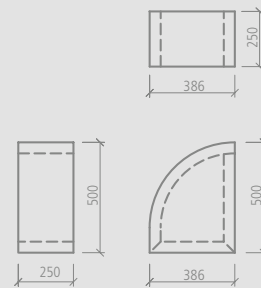

wedi Sanoasa® Bellina armrest

for Sanoasa Bellina bench element

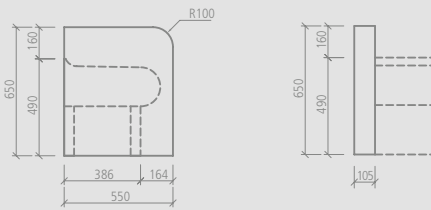
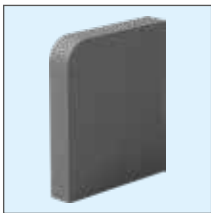

wedi Sanoasa® lounger 1

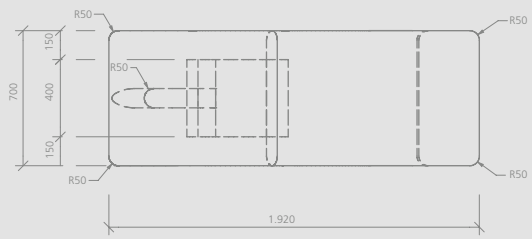
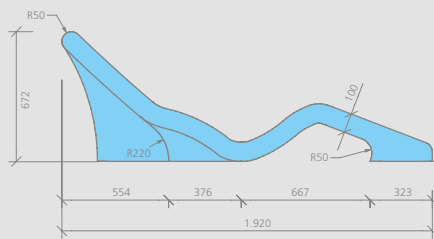

wedi Sanoasa® lounger 2

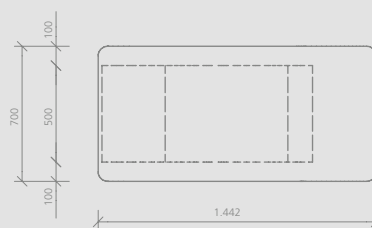
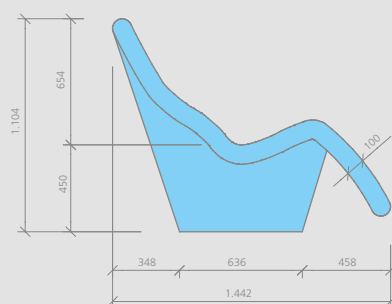

wedi Sanoasa® lounger 3

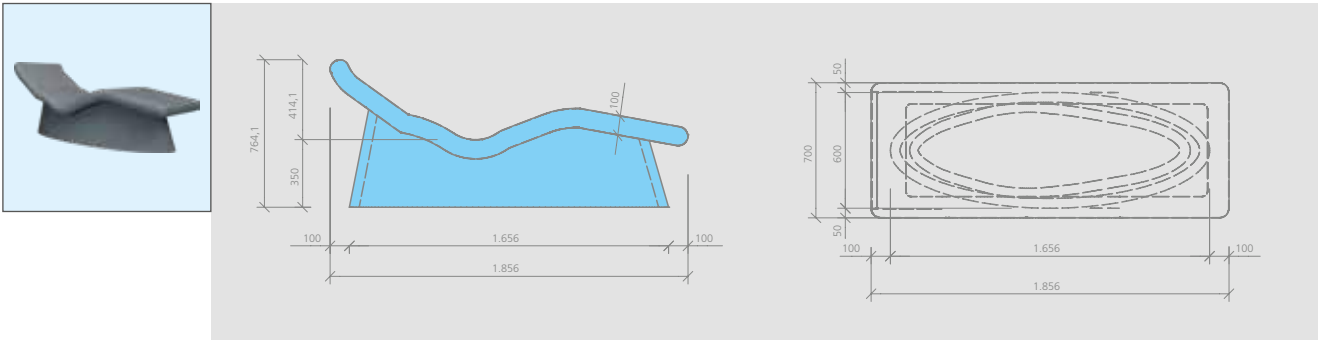

wedi Sanoasa® lounger 4

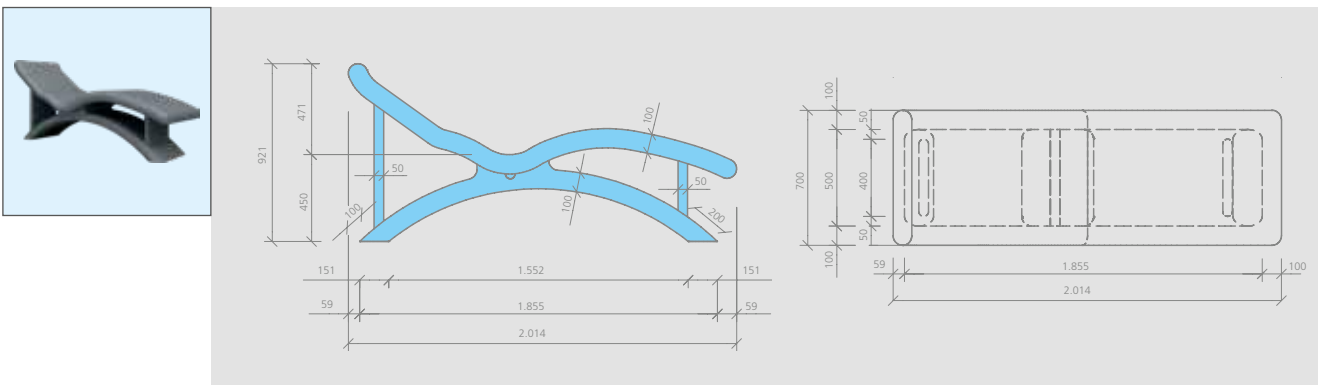

wedi Sanoasa® lounger 5

